



# NEW KITCHEN ADAPTS TO EVERYONE'S STYLE

Height adjustable lifts - for worktops and wall cupboards of your own choice

**Introducing** a new concept in kitchen design. The Indivo kitchen, where the height of all wall cupboards and worktops can be adjusted using special lifts, allowing users to work in the kitchen, whether they sit or stand.

The lifts can be adapted to most standard kitchen components allowing the flexibility to choose almost any style you like. And lifts can be used when installing a new kitchen or when retrofitting an existing kitchen for continued use.

## Flexible lifts

Being able to adjust the height of worktops and wall cupboards is a great help for almost everyone. The new Pressalit Care lifts mean that you can design your own height-adjustable kitchen.

## Height adjustment

Worktops and wall cupboards are adjusted to a comfortable height using switches on the worktop front.

The worktops can be adjusted vertically by 400 mm.

Wall cupboards can be moved diagonally, that is both vertically and forwards. From its highest position, the cupboard can be moved 350 mm downwards and 150 mm forwards.

## Safety feature

The worktop is equipped with a safety bar under the frame and the wall cupboards with a safety plate underneath. These prevent injury from pinching and crushing.



pressalit care®

**care**design  
specialist interiors



Phone 1300 798 744 Fax: 1300 793 644  
Email: info@caredesign.com.au Visit: www.caredesign.com.au

## Bench Tops

Lift incl. wall-mounted telescopic legs, cross brace, brackets and switch

Length: 600 - 1000 mm (2 brackets) **RK1010**

Length: 1001 - 1400 mm (2 brackets) **RK1011**

Length: 1401 - 2000 mm (3 brackets) **RK1012**

Length: 2001 - 2400 mm (4 brackets) **RK1013**

When ordering, please state the desired length.

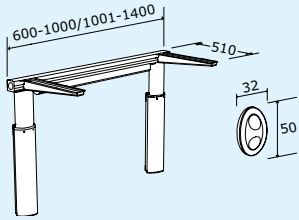

RK1010  
RK1011

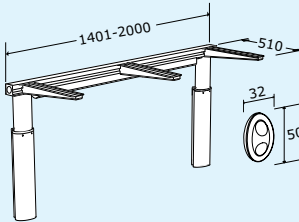

RK1012

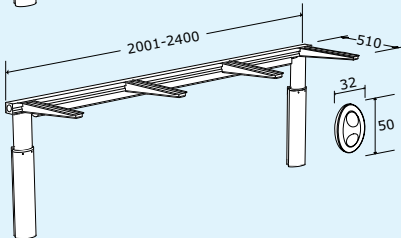

RK1013

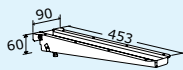

**Bracket**  
RK1040

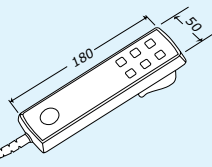

**Hand control**  
RK1045

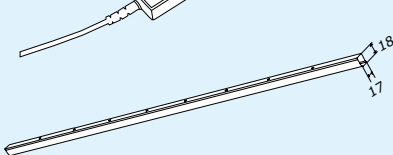

**Safety bar**  
RK1030

Safety bar for worktops, per metre.

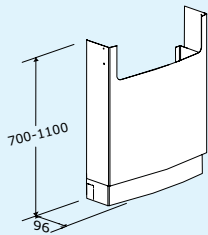

**Installation cover**  
RK1043000

Cover flexible connections for sink

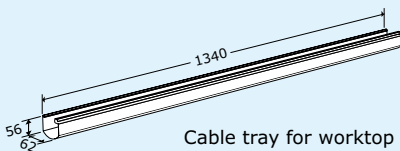

**Cable tray - horizontal**  
RK1050

Cable tray for worktop lifts, per metre.

## Cupboards

Lift incl. wall-mounted lift motor(s), 2 cross braces and switch

Length up to 1200 mm (1 motor) **RK1020**

Length up to 2400 mm (2 motors) **RK1021**

When ordering, please state the desired length.

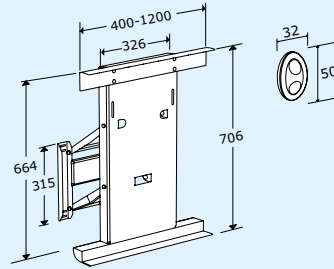

RK1020

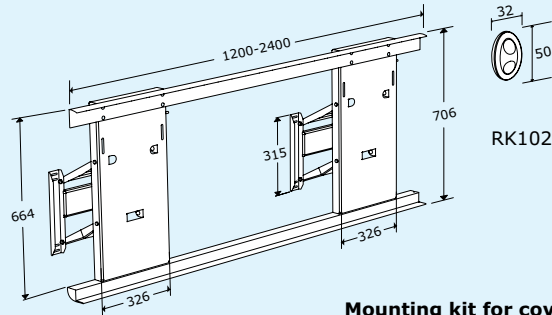

RK1021



**Mounting kit for cover plate**

RK1060 up to 1200 mm

RK1061 up to 2400 mm

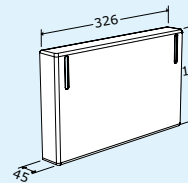

**Extension fitting for lift motor**

For installing cupboards higher than 704 mm.

RK1065 up to 1200 mm

RK1066 up to 2400 mm

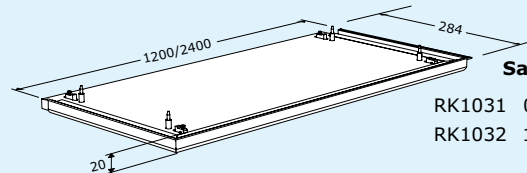

**Safety plate**

RK1031 0 - 1200 mm

RK1032 1201 - 2400 mm

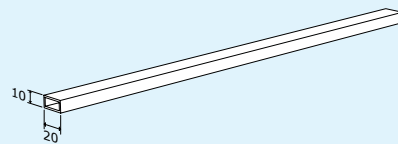

**Cable tray - vertical**  
RK1051000

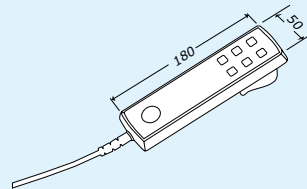

**Hand control**  
RK1045

**NB:** All cupboards attached to the same lift will move in unison. The wall-mounted lift motor will be visible if the wall cupboard is less than 400 mm wide. All the measurements are in mm.

Contact Caredesign for a more detailed design guide

**caredesign**  
specialist interiors

Phone: 1300 798 744 Fax: 1300 793 644

Email: [info@caredesign.com.au](mailto:info@caredesign.com.au)

Visit: [www.caredesign.com.au](http://www.caredesign.com.au)



Pressalit Care Indivo Kitchen meets all the minimum requirements in the relevant EU directives.



Guarantee: 3 years