



The Custodian™

Secure Bathroom Solutions

PROVIDING SAFETY AND SECURITY
WITH ENHANCED COMFORT AND CARE



Custodian™ of Care

Providing individual control and comfort while maintaining maximum safety and security, the Custodian™ Range is the complete secure bathroom solution designed to improve the rehabilitative process.

Custodian™'s modern and aesthetically pleasing design provides the user with the control and functionality, creating a therapeutic homelike environment.

The flexible range of products provides a wide variety of bathroom layout designs and construction methods while being safe, secure and long lasting.

Custodian™ features rotational operation, designed to provide the user with direct feedback for temperature and timing for a better experience.

Personalised thermostatic temperature control enhances the overall comfort for the user. While tailored individual hot water delivery, aids in rehabilitation and care.

The Custodian™ Range coupled with Enware's Smart Flow® Water Management System, provides the capability to manage and control the water temperature electronically with remote adjustment and security.







The series has been designed to exceed IK10 rating for improved robustness.

Disclaimer: At the time of print, products shown in this brochure were subject to approval for Watermark and WELS certification, as required by the Australian Building Codes Board (ABCB) and the Australian Government. Details of the application and approval will be made available through the following websites: www.waterrating.gov.au and www.abcb.gov.au .



Custodian™ Range Modules

Smart Flow® Enabled User Interface

	<p>All-in-1 Multi-panel Water Control for Basin, Shower and Toilet</p>		<p>Shower or Basin Single Controller</p>
	<p>Toilet and Basin Combi Unit Multi-panel Water Control</p>		<p>Toilet Dual Flush Control</p>
	<p>Shower and Basin Multi-panel Water Control</p>		<p>Ligature Resistant Shower Rose</p>
			<p>Ligature Resistant Basin Spout</p>

Note: Models available in front, rear and fixture mounted versions.

Typical Room Layout



All-in-1 Multi-panel Water Control for Basin, Shower and Toilet



Toilet and Basin Combi Unit Multi-panel Water Control



Shower and Basin Multi-panel Water Control



Product Architecture

Designed as a fully integrated electronic system, the Custodian™ Range allows for complete customisation of the water functions within a living space, making it the complete secure bathroom solution to improve the rehabilitation process.

As a Smart Flow® enabled product, the Electronic Control Hub, in combination with the Electronic Thermostatic Mixing Valve (eTMV) delivers the needs of the user as set by the Smart Flow® Water Management System. The intuitive interface provides a tailored front of wall experience for the user.



Smart Flow® LAN and Backbone Connection

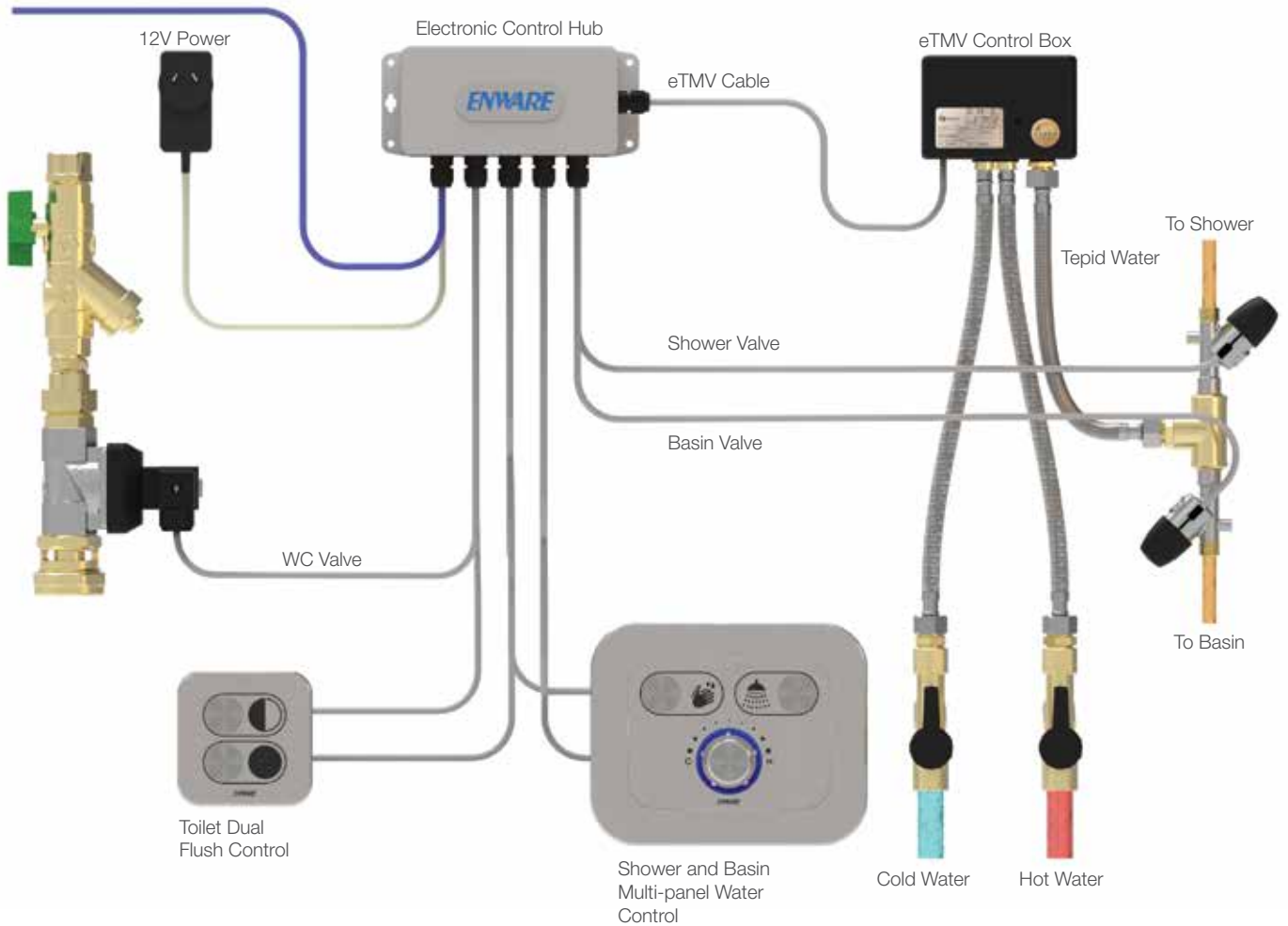

Smart Flow[®] Integration

Enware's Smart Flow[®] Enabled Fixtures interact seamlessly with Smart Flow[®] to provide accurate and reliable control and monitoring of all connection points.

The data is collected through the local hub which links seamlessly with the facility data network. The collated data is then stored for reporting through the Smart Flow[®] user interface.

Individual hubs connect to form a string of hubs. These hubs then feed back to the block LAN interface. This interface combines to form the backbone of the network, which all feed back to a common server creating a secure closed network.

Smart Flow[®] has the capability to integrate into the facility Building Management and Control System (BMCS), and the flexibility to provide a low level integration, with a link from the server to the BMCS to notify of any alarms or status scenarios. For high level integration the BACnet/IP protocol is used.

Smart Flow[®] can be customised and managed by corrections staff on site to meet specific operational needs such as:

- Enable/disable
- Run-times
- Lock-outs
- Maximum daily use
- Morning/evening shower period
- Shower end warning (when using the Custodian[™] Range).

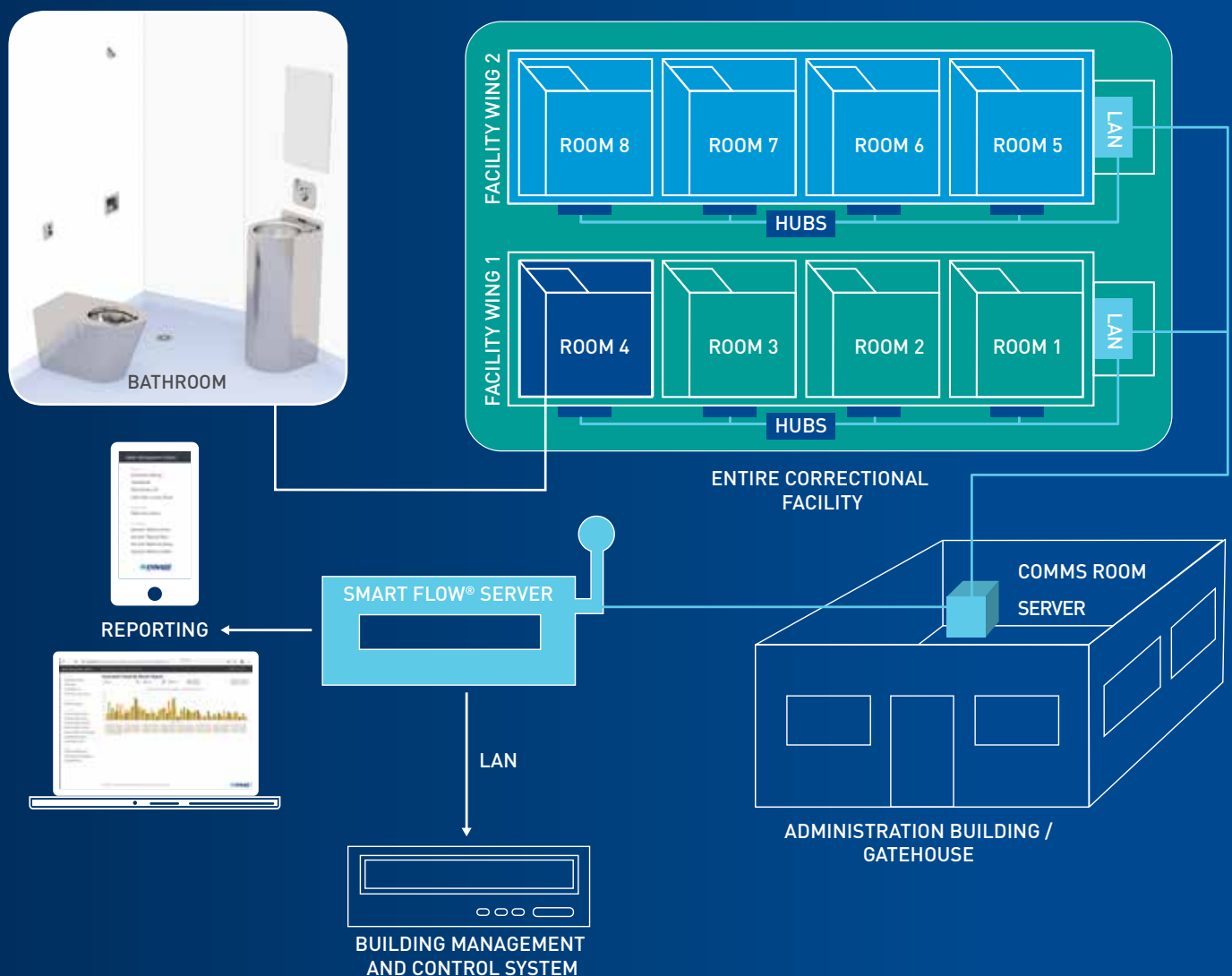

Correction Solutions

Smart Flow®, together with Smart Flow® Enabled Fixtures are designed and developed by Enware Australia.

Detention Range

As part of our correction solutions, we also offer the Enware Detention Range of secure and vandal resistant fixtures and fittings. Designed with minimal horizontal surfaces and concealed spaces, this range includes a smooth and clean finish. Incorporating manually operated tapware, touch activated Piezo technology and ligature resistant outlets this range features programmable run and time-out periods.

- Individual temperature control
- Rear mount
- Mechanical
- For brick, block and tilt up
- Smart Flow® enabled.

Enware Design Solutions

Enware provides a water delivery solution specific for each environment in your facility, including:

- Accommodation
- Commercial kitchen and food processing
- Medical and mental health facilities
- Outdoor space and common areas
- Education
- Public amenities (visitors).

Local Support and System Optimisation Services

Enware has the capability to provide local support and system optimisation services throughout your project, from system design, installation, commissioning through to long term performance management.





The Custodian™
Secure Bathroom Solutions